

VCR® Metal Gasket Face Seal Fittings



- 1/16 to 1 in. and 6 to 18 mm sizes
- High-purity stainless steels
- The original design, the authentic VCR brand

Contents

- Typical VCR Assemblies 2
- Features 3
- Materials of Construction 3
- Pressure Ratings 3
- Temperature Ratings 3
- Testing 3
- Cleaning 4
- Ultra-high-Purity Processing 4
- Ordering Information,
Pressure Ratings, and Dimensions 4



Glands

- Tube Butt Weld 4
- Socket Weld 6
- Male Weld 7
- Tube Adapter 7
- Blind 7



Bodies

- Male Connectors 8
- Female Connector 9
- Swagelok Tube Fitting Connector 9
- Male Unions 10
- Tube Butt Weld
Bulkhead Connector 10
- Coupling 11
- Reducers 11
- Elbows, Tee, Cross 11



Welded Assemblies

- Male NPT Connector 13
- Female NPT Connector 13
- Swagelok Tube Fitting Connector 13
- Rotating Female Union 13



Nuts, Caps, and Plugs 14



High-Flow Connections—“H” Type VCR

- Glands 15
- Bodies 15
- Nuts 16



Gaskets 17



Options and Accessories

- Flow Restrictors 18
- Lock and Tag Devices 18
- Side-Load Installation
Tool and Tray 18

Installation Instructions 19

Typical VCR Assemblies

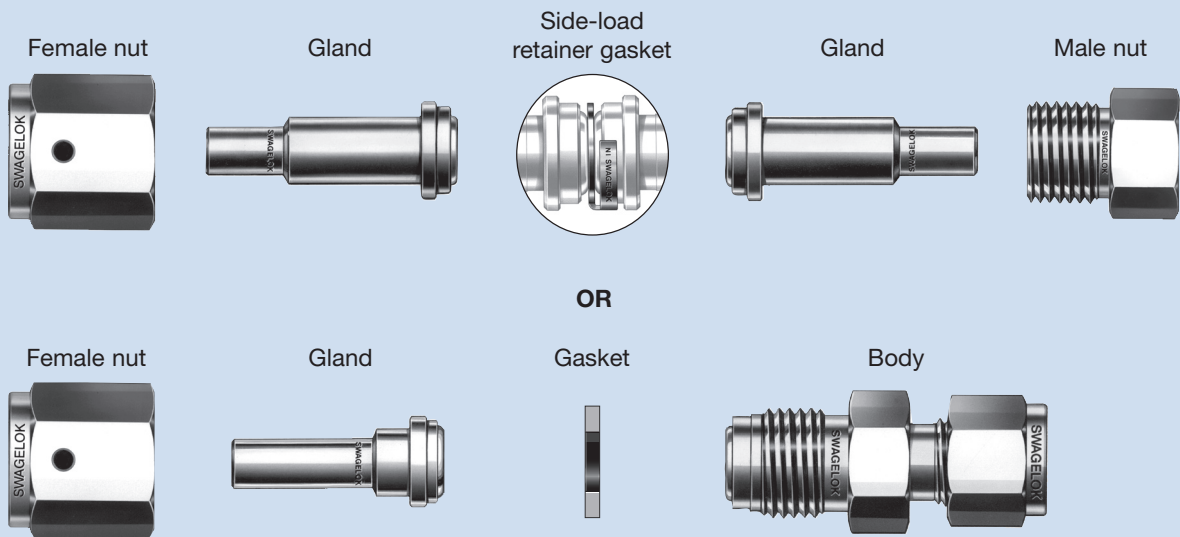

Features

Swagelok® VCR fittings offer the high purity of a metal-to-metal seal, providing leak-tight service from vacuum to positive pressure.

The seal on a VCR assembly is made when the gasket is compressed by two beads during the engagement of a male nut or body hex and a female nut.

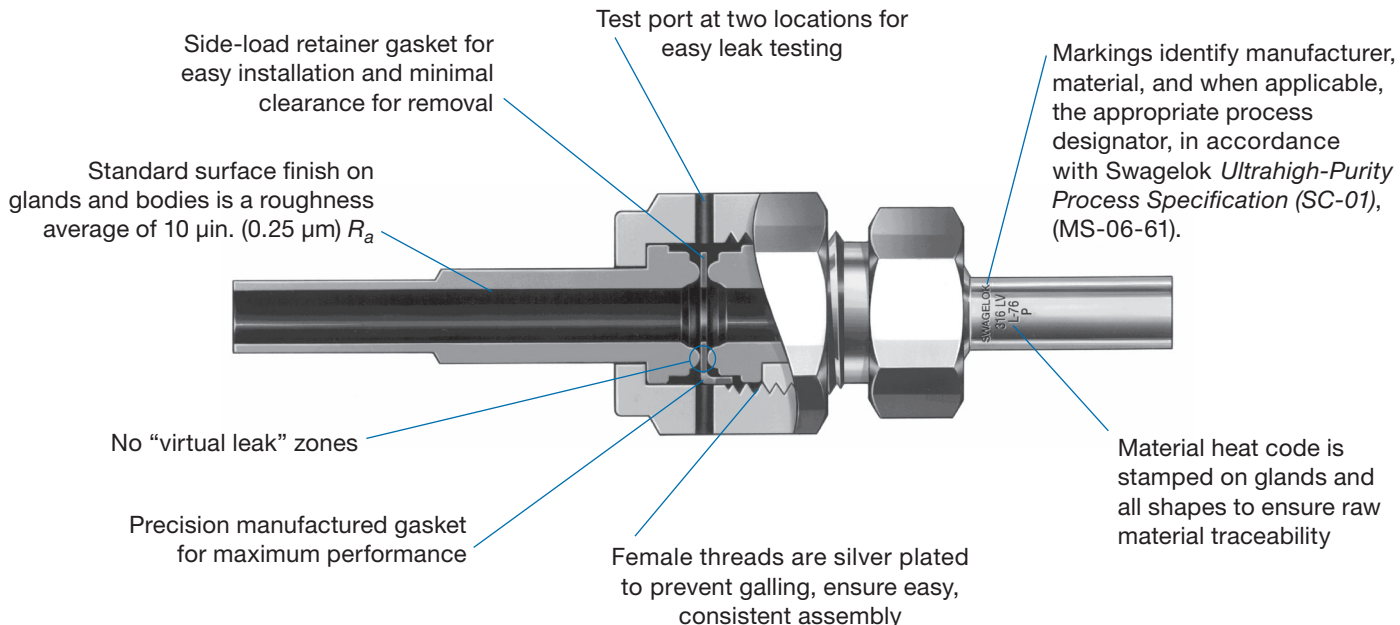
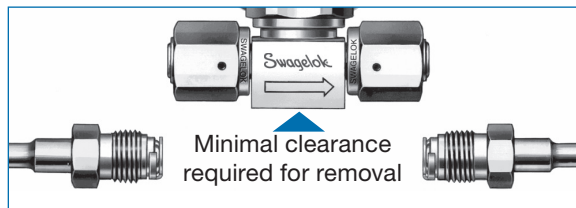

Materials of Construction

Material	Designator	Specification
Glands, Bodies, and Nuts		
316 stainless steel	SS	Bar stock: ASME SA479 ASTM A276 Forged shapes: ASME SA182 ASTM A314
S17400	SS	Split-nut assemblies: MPIF Standard 35
316L stainless steel	316L	Bar stock: ASME SA479 ASTM A276 Forged shapes: ASME A182
316L VAR stainless steel	6LV	SEMI F20 High-Purity ^①
Gaskets		
Nickel	NI	ASTM F3
316L stainless steel	SS	ASTM A240
Copper	CU	ASTM B152

① 20 % minimum elongation allowed.

Plating

VCR female nuts are silver plated. Avoid chemical processes used for cleaning, electropolishing, and passivation that will remove plating. If the plating is damaged or removed, thread galling may occur, damaging fitting components and preventing a proper seal.

Pressure Ratings

- All ratings comply with calculations in accordance with ASME Code for Pressure Piping B31.3, Process Piping, and ASME B31.1, Power Piping.
- Working pressure ratings determined at room temperature with gasket materials shown.

Temperature Ratings

Components	Material	Temperature, °F (°C)
Fittings	316 stainless steel	1000 (537)
	316L stainless steel	
	316L VAR stainless steel	
Gaskets	316L stainless steel	1000 (537)
	Nickel	600 (315)
	Copper	400 (204)

Testing

The VCR fitting design has been helium leak tested to a maximum leak rate of 4×10^{-9} std cm³/s with silver-plated and copper gaskets and to a maximum leak rate of 4×10^{-11} std cm³/s with unplated gaskets.

Cleaning

Components are cleaned to remove oil, grease, and loose particles. For more information, see Swagelok *Standard Cleaning and Packaging (SC-10)*, [MS-06-62](#).

Ultrahigh-Purity Processing

A variety of VCR face seal glands and bodies is available with controlled surface finishes, electropolished, and specially cleaned to meet ultrahigh-purity system requirements. For more information, see Swagelok *Ultrahigh-Purity Process Specification (SC-01)*, [MS-06-61](#)

Ordering Information, Pressure Ratings, and Dimensions

- Dimensions are for reference only and are subject to change.
- The E dimension refers to the smallest nominal inside diameter of the part.
- To order fittings manufactured in accordance with Swagelok *Ultrahigh-Purity Process Specification (SC-01)*, [MS-06-61](#) add **P** to the ordering number.

Example: 6LV-4-VCR-3-4TB7P

Glands

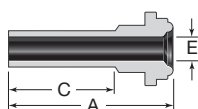

Short Tube Butt Weld

Tube Size	Nominal Wall Thickness	VCR Size in.	Ordering Number	Dimensions			Working Pressure		
				A	C	E	Ni	SS	Cu
Dimensions, in. (mm)							psig (bar)		
1/8	0.028	1/8	6LV-2-VCR-3S-2TB7 ^①	1.08 (27.4)	0.75 (19.1)	0.07 (1.8)	8500 (585)	8500 (585)	7200 (496)
		1/4	6LV-4-VCR-3S-2TB7	1.10 (27.9)			8000 (551)	8500 (585)	6400 (440)
1/4	0.035	1/4	6LV-4-VCR-3S-4TB2	0.60 (15.2)	0.25 (6.4)	0.18 (4.6)	5100 (351)	5100 (351)	5100 (351)
			6LV-4-VCR-3S-4TB3	0.72 (18.3)	0.38 (9.6)				
			6LV-4-VCR-3S-4TB7	1.10 (27.9)	0.75 (19.1)				
		1/2	6LV-8-VCR-3S-4TB7	1.12 (28.4)	0.75 (19.1)		3500 (241)	4300 (296)	2800 (192)
3/8	0.035	1/2	6LV-8-VCR-3S-6TB2	0.62 (15.7)	0.25 (6.4)	0.31 (7.9)	3300 (227)	3300 (227)	2800 (192)
			6LV-8-VCR-3S-6TB7	1.12 (28.4)	0.75 (19.1)				
1/2	0.049	1/2	6LV-8-VCR-3S-8TB2	0.62 (15.7)	0.25 (6.4)	0.40 (10.2)	3500 (241)	3700 (254)	2800 (192)
			6LV-8-VCR-3S-8TB3	0.74 (18.8)	0.38 (9.6)				
			6LV-8-VCR-3S-8TB7	1.12 (28.4)	0.75 (19.1)				
Dimensions, mm (in.)							bar (psig)		
6	1.0	1/4	6LV-4-VCR-3S-6MTB7	29.5 (1.16)	19.1 (0.75)	4.0 (0.16)	468 (6800)	468 (6800)	440 (6400)
8	1.0	1/4	6LV-4-VCR-3S-8MTB7	29.5 (1.16)		6.0 (0.24)	337 (4900)	337 (4900)	337 (4900)
10	1.0	1/2	6LV-8-VCR-3S-10MTB7	29.5 (1.16)		8.0 (0.31)	241 (3500)	241 (3500)	192 (2800)
12	1.0	1/2	6LV-8-VCR-3S-12MTB7	29.5 (1.16)		10.0 (0.39)	213 (3100)	213 (3100)	192 (2800)
18	1.5	3/4	6LV-12-VCR-3S-18MTB7	31.0 (1.22)		15.0 (0.59)	206 (3000)	206 (3000)	165 (2400)

① Not designed for gasket retainer assembly.

Glands

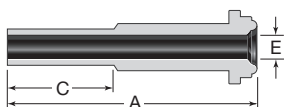

Long Tube Butt Weld

Tube Size	Nominal Wall Thickness	VCR Size in.	Ordering Number	Dimensions			Working Pressure		
				A	C	E	Ni	SS	Cu
Dimensions, in. (mm)							psig (bar)		
1/8	0.028	1/8	6LV-2-VCR-3-2TB7 ^①	1.42 (36.1)	0.75 (19.1)	0.07 (1.8) ^②	8500 (585)	8500 (585)	7200 (496)
1/4	0.035	1/4	6LV-4-VCR-3-4TB2	1.20 (30.5)	0.25 (6.4)	0.18 (4.6)	5100 (351)	5100 (351)	5100 (351)
			6LV-4-VCR-3-02205	1.31 (33.3)	0.36 (9.1)				
			6LV-4-VCR-3-4TB3	1.32 (33.5)	0.38 (9.6)				
			6LV-4-VCR-3-4TB7	1.70 (43.2)	0.75 (19.1)				
		1/2	6LV-8-VCR-3-4TB7	1.80 (45.7)	0.75 (19.1)		3500 (241)	4300 (296)	2800 (192)
3/8	0.035	1/2	6LV-8-VCR-3-6TB2	1.29 (32.8)	0.25 (6.4)	0.31 (7.9)	3300 (227)	3300 (227)	2800 (192)
			6LV-8-VCR-3-6TB7	1.79 (45.5)	0.75 (19.1)				
1/2	0.049	1/2	6LV-8-VCR-3-8TB2	1.29 (32.8)	0.25 (6.4)	0.40 (10.2)	3500 (241)	3700 (254)	2800 (192)
			6LV-8-VCR-3-8TB3	1.41 (35.8)	0.38 (9.6)				
			6LV-8-VCR-3-8TB7	1.79 (45.5)	0.75 (19.1)				
3/4	0.049	3/4	6LV-12-VCR-3-12TB7	2.03 (51.6)	0.75 (19.1)	0.65 (16.5)	2400 (165)	2400 (165)	2400 (165)
1	0.065	1	6LV-16-VCR-3-16TB7	2.32 (58.9)	0.75 (19.1)	0.87 (22.1)	2400 (165)	2400 (165)	1900 (130)
Dimensions, mm (in.)							bar (psig)		
6	1.0	1/4	6LV-4-VCR-3-6MTB7	43.2 (1.70)	19.1 (0.75)	4.0 (0.16)	468 (6800)	468 (6800)	440 (6400)
8	1.0	1/4	6LV-4-VCR-3-8MTB7	43.2 (1.70)		6.0 (0.24)	337 (4900)	337 (4900)	337 (4900)
10	1.0	1/2	6LV-8-VCR-3-10MTB7	45.5 (1.79)		8.0 (0.31)	241 (3500)	241 (3500)	192 (2800)
12	1.0	1/2	6LV-8-VCR-3-12MTB7	45.5 (1.79)		10.0 (0.39)	213 (3100)	213 (3100)	192 (2800)
18	1.5	3/4	6LV-12-VCR-3-18MTB7	51.6 (2.03)		15.0 (0.59)	206 (3000)	206 (3000)	165 (2400)

① Not designed for gasket retainer assembly.

② May contain internal diameter transitions.

Short Automatic Tube Butt Weld

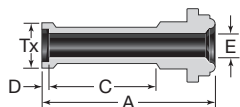

Tube Size	Nominal Wall Thickness	VCR Size in.	Ordering Number	Dimensions					Working Pressure		
				A	C	D	E	Tx	Ni	SS	Cu
Dimensions, in. (mm)							psig (bar)				
1/4	0.035	1/4	316L-4-VCR-3AS	1.12 (28.4)	0.75 (19.1)	0.02 (0.5)	0.18 (4.6)	0.29 (7.4)	5100 (351)	5100 (351)	5100 (351)
3/8	0.035	1/2	316L-8-VCR-3AS6	1.15 (29.2)		0.03 (0.8)	0.31 (7.9)	0.41 (10.4)	3300 (227)	3300 (227)	2800 (192)
1/2	0.049	1/2	316L-8-VCR-3AS	1.16 (29.5)		0.04 (1.0)	0.40 (10.2)	0.55 (14.0)	3500 (241)	3700 (254)	2800 (192)
Dimensions, mm (in.)							bar (psig)				
6	1.0	1/4	316L-4-VCR-3-6MAS	30.0 (1.18)	19.1 (0.75)	0.5 (0.02)	4.0 (0.16)	6.8 (0.27)	468 (6800)	468 (6800)	440 (6400)
8		1/4	316L-4-VCR-3-8MAS	30.2 (1.19)		0.8 (0.03)	6.0 (0.24)	8.9 (0.35)	337 (4900)	337 (4900)	337 (4900)
10		1/2	316L-8-VCR-3-10MAS	31.0 (1.22)		0.8 (0.03)	8.0 (0.31)	10.9 (0.43)	241 (3500)	241 (3500)	192 (2800)
12		1/2	316L-8-VCR-3-12MAS	30.5 (1.20)		1.0 (0.04)	10.0 (0.39)	13.2 (0.52)	213 (3100)	213 (3100)	192 (2800)

Glands

Long Automatic Tube Butt Weld

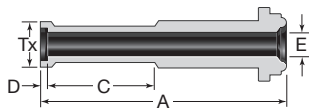

Tube Size	Nominal Wall Thickness	VCR Size in.	Ordering Number	Dimensions					Working Pressure		
				A	C	D	E	Tx	Ni	SS	Cu
Dimensions, in. (mm)								psig (bar)			
1/4	0.035	1/4	316L-4-VCR-3A	1.72 (43.7)	0.75 (19.1)	0.02 (0.5)	0.18 (4.6)	0.29 (7.4)	5100 (351)	5100 (351)	5100 (351)
		1/2	316L-8-VCR-3A4	1.82 (46.2)					3500 (241)	4300 (296)	2800 (192)
3/8	0.035	1/2	316L-8-VCR-3A6	1.82 (46.2)	0.75 (19.1)	0.03 (0.8)	0.31 (7.9)	0.41 (10.4)	3300 (227)	3300 (227)	2800 (192)
1/2	0.049	1/2	316L-8-VCR-3A	1.83 (46.5)	0.75 (19.1)	0.04 (1.0)	0.40 (10.2)	0.55 (14.0)	3500 (241)	3700 (254)	2800 (192)
3/4	0.049	3/4	316L-12-VCR-3A	2.07 (52.6)	0.75 (19.1)	0.04 (1.0)	0.65 (16.5)	0.80 (20.3)	2400 (165)	2400 (165)	2400 (165)
1	0.065	1	316L-16-VCR-3A	2.57 (65.3)	0.96 (24.4)	0.04 (1.0)	0.87 (22.1)	1.06 (26.9)	2400 (165)	2400 (165)	1900 (130)
Dimensions, mm (in.)								bar (psig)			
6	1.0	1/4	316L-4-VCR-3-6MA	43.7 (1.72)	19.1 (0.75)	0.5 (0.02)	4.0 (0.16)	6.8 (0.27)	468 (6800)	468 (6800)	440 (6400)
12	1.0	1/2	316L-8-VCR-3-12MA	46.5 (1.83)		1.0 (0.04)	10.0 (0.39)	13.2 (0.52)	213 (3100)	213 (3100)	192 (2800)
18	1.5	3/4	316L-12-VCR-3-18MA	52.6 (2.07)		1.0 (0.04)	15.0 (0.59)	19.3 (0.76)	206 (3000)	206 (3000)	165 (2400)

Socket Weld

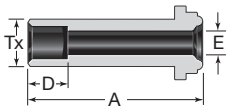

Tube Socket Size	VCR Size	Ordering Number	Dimensions				Working Pressure		
			A	D	E	Tx	Ni	SS	Cu
Dimensions, in. (mm)						psig (bar)			
1/16	1/8	SS-1-VCR-3 ^{①②}	0.70 (17.8)	0.10 (2.5)	0.05 (1.3)	0.13 (3.3)	9000 (620)	9000 (620)	7200 (496)
1/8	1/8	SS-2-VCR-3 ^②	0.70 (17.8)	0.10 (2.5)	0.09 (2.3)	0.20 (5.1)	7100 (489)	7100 (489)	7100 (489)
1/4	1/4	SS-4-VCR-3	1.31 (33.3)	0.28 (7.1)	0.18 (4.6)	0.35 (8.9)	5500 (378)	5500 (378)	5500 (378)
3/8	1/2	SS-6-VCR-3 ^③	1.50 (38.1)	0.31 (7.9)	0.28 (7.1)	0.60 (15.2)	3500 (241)	4300 (296)	2800 (192)
1/2	1/2	SS-8-VCR-3	1.50 (38.1)	0.38 (9.6)	0.40 (10.2)	0.60 (15.2)	3000 (206)	3000 (206)	2800 (192)
5/8	5/8	SS-10-VCR-3	1.56 (39.6)	0.41 (10.4)	0.50 (12.7)	0.72 (18.3)	2800 (192)	2800 (192)	2400 (165)
3/4	3/4	SS-12-VCR-3	2.00 (50.8)	0.44 (11.2)	0.62 (15.7)	0.88 (22.4)	2800 (192)	2800 (192)	2400 (165)
1	1	SS-16-VCR-3	2.22 (56.4)	0.62 (15.7)	0.87 (22.1)	1.19 (30.2)	2400 (165)	3000 (206)	1900 (130)

- ① Uses 1/8 in. gasket and nut.
- ② Not designed for gasket retainer assembly.
- ③ Uses 1/2 in. gasket and nut.

Short Socket Weld

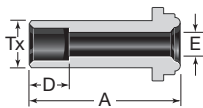

Tube Socket Size	VCR Size	Ordering Number	Dimensions				Working Pressure		
			A	D	E	Tx	Ni	SS	Cu
Dimensions, in. (mm)						psig (bar)			
1/4	1/4	SS-4-VCR-3-.50LG	0.50 (12.7)	0.28 (7.1)	0.18 (4.6)	0.35 (8.9)	5500 (378)	5500 (378)	5500 (378)
		SS-4-VCR-3-.75LG	0.75 (19.1)						

Glands

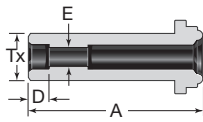

Reducing Socket Weld

Tube Socket Size	VCR Size	Ordering Number	Dimensions				Working Pressure		
			A	D	E	Tx	Ni	SS	Cu
Dimensions, in. (mm)						psig (bar)			
1/8	1/4	SS-4-VCR-3-2TSW	1.31 (33.3)	0.10 (2.5)	0.09 (2.3) ^①	0.35 (8.9)	8000 (551)	8000 (551)	6400 (440)
1/4	1/2	SS-8-VCR-3-4TSW	1.50 (38.1)	0.28 (7.1)	0.18 (4.6)	0.60 (15.2)	3500 (241)	4300 (296)	2800 (192)

① May contain internal diameter transitions.

Male Weld

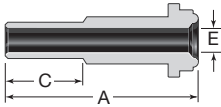

Tube Size	VCR Size	Ordering Number	Dimensions			Working Pressure		
			A	C	E	Ni	SS	Cu
Dimensions, in. (mm)						psig (bar)		
1/8	1/8	SS-2-VCR-3-2MTW ^①	0.70 (17.8)	0.28 (7.1)	0.06 (1.5) ^②	9000 (620)	11 200 (771)	7200 (496)
	1/4	SS-4-VCR-3-2MTW	1.31 (33.3)			8000 (551)	10 000 (689)	6400 (440)
1/4	1/4	SS-4-VCR-3-4MTW	1.31 (33.3)	0.41 (10.4)	0.12 (3.0)	8000 (551)	10 000 (689)	6400 (440)
	1/2	SS-8-VCR-3-4MTW	1.50 (38.1)			3500 (241)	4300 (296)	2800 (192)
3/8	1/2	SS-8-VCR-3-6MTW	1.50 (38.1)	0.41 (10.4)	0.28 (7.1)	3500 (241)	4300 (296)	2800 (192)
1/2	1/2	SS-8-VCR-3-8MTW	1.50 (38.1)	0.50 (12.7)	0.40 (10.2)	3500 (241)	3700 (254)	2800 (192)
3/4	3/4	SS-12-VCR-3-12MTW	2.00 (50.8)	0.62 (15.7)	0.53 (13.5)	3000 (206)	3700 (254)	2400 (165)
1	1	SS-16-VCR-3-16MTW	2.22 (56.4)	0.81 (20.6)	0.75 (19.1)	2400 (165)	3000 (206)	1900 (130)

① Not designed for gasket retainer assembly.

② May contain internal diameter transitions.

Tube Adapter

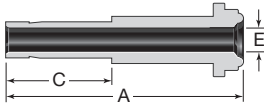

Tube Size	VCR Size	Ordering Number	Dimensions			Working Pressure		
			A	C	E	Ni	SS	Cu
Dimensions, in. (mm)						psig (bar)		
1/4	1/4	SS-4-VCR-3-4TA	1.62 (41.0)	0.64 (16.2)	0.17 (4.3)	8000 (551)	10 000 (689)	6400 (440)
3/8	1/2	SS-8-VCR-3-6TA	1.81 (46.0)	0.70 (17.8)	0.27 (6.8) ^①	3500 (241)	4300 (296)	2800 (192)
1/2	1/2	SS-8-VCR-3-8TA	1.94 (49.3)	0.96 (24.4)	0.37 (9.4)	3500 (241)	4300 (296)	2800 (192)

① May contain internal diameter transitions.

Blind (Undrilled) Gland



VCR Size	Ordering Number	A
Dimensions, in. (mm)		
1/8	SS-2-VCR-3-BL ^①	0.70 (17.8)
1/4	SS-4-VCR-3-BL	1.31 (33.3)
1/2	SS-8-VCR-3-BL	1.50 (38.1)
3/4	SS-12-VCR-3-BL	2.00 (50.8)
1	SS-16-VCR-3-BL	2.22 (56.4)

① Not designed for gasket retainer assembly.

Bodies

Male NPT Connector^①

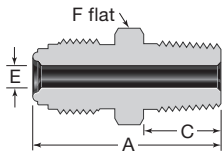

NPT Size	VCR Size	Ordering Number	Dimensions				Working Pressure		
			A	C	E	F	Ni	SS	Cu
			Dimensions, in. (mm)				psig (bar)		
1/16	1/8	SS-2-VCR-1-1 ^②	1.07 (27.2)	0.38 (9.6)	0.09 (2.3) ^③	3/8	9000 (620)	9000 (620)	7200 (496)
1/8	1/8	SS-2-VCR-1-2 ^②	1.07 (27.2)	0.38 (9.6)	0.09 (2.3) ^③	7/16	9000 (620)	9000 (620)	7200 (496)
	1/4	SS-4-VCR-1-2	1.31 (33.3)		0.18 (4.6)	5/8	8000 (551)	10 000 (689)	6400 (440)
1/4	1/4	SS-4-VCR-1-4	1.49 (37.8)	0.56 (14.2)	0.18 (4.6)	5/8	8000 (551)	10 000 (689)	6400 (440)
	1/2	SS-8-VCR-1-4	1.65 (41.9)		0.28 (7.1) ^③	15/16	3500 (241)	4300 (296)	2800 (192)
3/8	1/2	SS-8-VCR-1-6	1.65 (41.9)	0.56 (14.2)	0.38 (9.6)	15/16	3500 (241)	4300 (296)	2800 (192)
1/2	1/2	SS-8-VCR-1-8	1.84 (46.7)	0.75 (19.1)	0.40 (10.2)	15/16	3500 (241)	4300 (296)	2800 (192)
3/4	3/4	SS-12-VCR-1-12	2.19 (55.6)	0.75 (19.1)	0.62 (15.7)	1 5/16	3000 (206)	3700 (254)	2400 (165)
1	1	SS-16-VCR-1-16	2.47 (62.7)	0.94 (23.9)	0.87 (22.1)	1 5/8	2400 (165)	3000 (206)	1900 (130)

Select male connectors are available with ISO/BSP tapered thread (RT) ends. Contact your authorized Swagelok representative.

- ① VCR components with fixed threads must remain stationary during installation. These fitting connections should be assembled only to glands with rotating male or female threaded nuts.
- ② Not designed for gasket retainer assembly.
- ③ May contain internal diameter transitions.

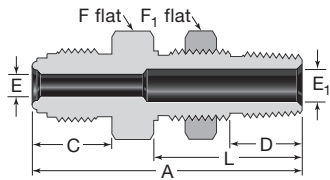

Male NPT Bulkhead Connector^①

NPT Size	VCR Size	Ordering Number	Dimensions										Working Pressure		
			A	C	D	E	E ₁	F	F ₁	L	Panel Hole Dia	Max Panel Thickness	Ni	SS	Cu
			Dimensions, in. (mm)										psig (bar)		
1/4	1/4	SS-4-VCR-A1-4M	2.21 (56.1)	0.62 (15.7)	0.56 (14.2)	0.18 (4.6)	0.28	13/16	13/16	1.24 (31.5)	21/32 (16.8)	0.38 (9.7)	8000 (551)	8000 (551)	6400 (440)
	1/2	SS-8-VCR-A1-4M	2.34 (59.4)	0.75 (19.1)		0.40 (10.2)	7.1	15/16					3500 (241)	4300 (296)	2800 (192)

① VCR components with fixed threads must remain stationary during installation. These fitting connections should be assembled only to glands with rotating male or female threaded nuts.

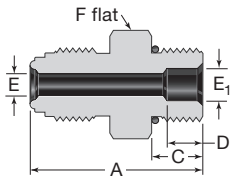

Straight Thread O-Ring Seal Male Connector^①

Straight Thread Size	VCR Size	Uniform O-Ring ^② Size	Ordering Number	Dimensions						Working Pressure		
				A	C	D	E	E ₁	F	Ni	SS	Cu
				Dimensions, in. (mm)						psig (bar)		
9/16-18	1/4	906	SS-4-VCR-1-00032	1.33 (33.8)	0.39 (9.9)	0.25 (6.4)	0.18 (4.6)	0.28 (7.1)	3/4	4500 (310)	4500 (310)	4500 (310)
7/8-14	1/2	910	SS-8-VCR-1-00176	1.66 (42.2)	0.50 (12.7)	0.40 (10.2)	0.28 (7.1)	0.59 (15.0)	1	3500 (241)	3500 (241)	2800 (192)
9/16-18	1/2	906	SS-8-VCR-1-01081	1.48 (37.6)	0.39 (9.9)	—	0.28 (7.1)	0.28 (7.1)	15/16	3500 (241)	4300 (296)	2800 (192)

① VCR components with fixed threads must remain stationary during installation. These fitting connections should be assembled only to glands with rotating male or female threaded nuts.

② Fluorocarbon FKM is standard, other materials are available. O-rings are assembled with a silicone vacuum grease.

Bodies

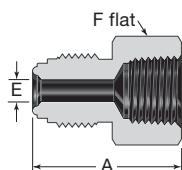

Female NPT Connector^①

NPT Size	VCR Size	Ordering Number	Dimensions			Working Pressure		
			A	E	F	Ni	SS	Cu
Dimensions, in. (mm)						psig (bar)		
1/16	1/8	SS-2-VCR-7-1 ^②	1.10 (27.9)	0.09 (2.3)	7/16	6700 (461)	6700 (461)	6700 (461)
1/8	1/8	SS-2-VCR-7-2 ^②	1.19 (30.2)	0.09 (2.3)	9/16	6500 (447)	6500 (447)	6500 (447)
	1/4	SS-4-VCR-7-2	1.41 (35.8)	0.18 (4.6)	5/8	8000 (551)	8000 (551)	6400 (440)
1/4	1/4	SS-4-VCR-7-4	1.54 (39.1)	0.18 (4.6)	3/4	6600 (454)	6600 (454)	6400 (440)
3/8	1/2	SS-8-VCR-7-6	1.76 (44.7)	0.40 (10.2)	15/16	3500 (241)	4300 (296)	2800 (192)
1/2	1/2	SS-8-VCR-7-8	1.99 (50.5)	0.40 (10.2)	1 1/16	3500 (241)	4300 (296)	2800 (192)
3/4	3/4	SS-12-VCR-7-12	2.36 (59.9)	0.62 (15.7)	1 5/16	3000 (206)	3700 (254)	2400 (165)
1	1	SS-16-VCR-7-16	2.51 (63.8)	0.87 (22.1)	1 5/8	2400 (165)	3000 (206)	1900 (130)

- ① VCR components with fixed threads must remain stationary during installation. These fitting connections should be assembled only to glands with rotating male or female threaded nuts.
- ② Not designed for gasket retainer assembly.

Swagelok Tube Fitting Connector^①

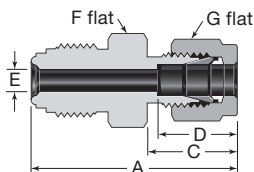

Tube Size	VCR Size	Ordering Number	Dimensions						Working Pressure		
			A	C	D	E	F	G	Ni	SS	Cu
Dimensions, in. (mm)									psig (bar)		
1/8	1/4	SS-4-VCR-6-200	1.53 (38.9)	0.60 (15.2)	0.50 (12.7)	0.09 (2.3) ^②	5/8	7/16	8000 (551)	10 000 (689)	6400 (440)
1/4	1/4	SS-4-VCR-6-400	1.62 (41.1)	0.70 (17.8)	0.60 (15.2)	0.18 (4.6)	5/8	9/16	8000 (551)	10 000 (689)	6400 (440)
3/8	1/2	SS-8-VCR-6-600	1.84 (46.7)	0.76 (19.3)	0.66 (16.8)	0.28 (7.1) ^②	15/16	11/16	3500 (241)	4300 (296)	2800 (192)
1/2	1/2	SS-8-VCR-6-810	1.95 (49.5)	0.86 (21.8)	0.90 (22.9)	0.40 (10.2)	15/16	7/8	3500 (241)	4300 (296)	2800 (192)

- Dimensions A, C, and D are typical finger-tight. Swagelok nuts and ferrules are provided assembled, as shown. For tubing maximum pressure ratings for use with Swagelok tube fittings, see Swagelok *Tubing Data*, MS-01-107.
- ① VCR components with fixed threads must remain stationary during installation. These fitting connections should be assembled only to glands with rotating male or female threaded nuts.
 - ② May contain internal diameter transitions.

Swagelok Tube Fitting Bulkhead Connector^①

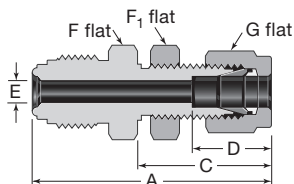

Tube Size	VCR Size	Ordering Number	Dimensions									Working Pressure		
			A	C	D	E	F	F ₁	G	Panel Hole Size	Max Panel Thickness	Ni	SS	Cu
Dimensions, in. (mm)												psig (bar)		
1/4	1/4	SS-4-VCR-A1-400	2.25 (57.2)	1.32 (33.5)	0.60 (15.2)	0.18 (4.6)	5/8	5/8	9/16	15/32 (11.9)	0.40 (10.2)	8000 (551)	10 000 (689)	6400 (440)
		SS-4-VCR-A1S-400	1.88 (47.8)	1.05 (26.7)							0.13 (3.3)	8000 (551)	10 000 (689)	6400 (440)
3/8	1/2	SS-8-VCR-A1-600	2.54 (64.5)	1.45 (36.8)	0.66 (16.8)	0.28 (7.1)	15/16	3/4	11/16	19/32 (15.0)	0.44 (11.2)	3500 (241)	4300 (296)	2800 (192)
1/2	1/2	SS-8-VCR-A1-810	2.74 (69.6)	1.65 (41.9)	0.90 (22.9)	0.40 (10.2)	15/16	15/16	7/8	25/32 (19.8)	0.50 (12.7)	3500 (241)	4300 (296)	2800 (192)

- Dimensions A, C, and D are typical finger-tight. Swagelok nuts and ferrules are provided assembled, as shown. For tubing maximum pressure ratings for use with Swagelok tube fittings, see Swagelok *Tubing Data*, MS-01-107.
- ① VCR components with fixed threads must remain stationary during installation. These fitting connections should be assembled only to glands with rotating male or female threaded nuts.

Bodies

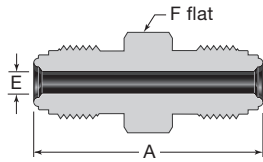

Male Union ^①

VCR Size	Ordering Number	Dimensions			Working Pressure		
		A	E	F	Ni	SS	Cu
Dimensions, in. (mm)					psig (bar)		
1/8	SS-2-VCR-6-DM ^②	1.13 (28.7)	0.09 (2.3)	3/8	9000 (620)	11 200 (771)	7200 (496)
1/4	SS-4-VCR-6-DM	1.55 (39.4)	0.18 (4.6)	5/8	8000 (551)	10 000 (689)	6400 (440)
1/2	SS-8-VCR-6-DM	1.84 (46.7)	0.40 (10.2)	15/16	3500 (241)	4300 (296)	2800 (192)
3/4	SS-12-VCR-6-DM	2.44 (62.0)	0.62 (15.7)	1 5/16	3000 (206)	3700 (254)	2400 (165)
1	SS-16-VCR-6-DM	2.59 (65.8)	0.87 (22.1)	1 5/8	2400 (165)	3000 (206)	1900 (130)

① VCR components with fixed threads must remain stationary during installation. These fitting connections should be assembled only to glands with rotating male or female threaded nuts.

② Not designed for gasket retainer assembly.

Male Reducing Union ^①

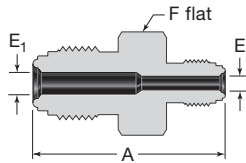

VCR Size	VCR Size	Ordering Number	Dimensions				Working Pressure		
			A	E	E ₁	F	Ni	SS	Cu
Dimensions, in. (mm)						psig (bar)			
1/4	1/8	SS-4-VCR-6-DM-2 ^②	1.37 (34.8)	0.09 (2.3)	0.18 (4.6)	5/8	8000 (551)	10 000 (689)	6400 (440)
1/2	1/4	SS-8-VCR-6-DM-4	1.71 (43.4)	0.18 (4.6)	0.40 (10.2)	15/16	3500 (241)	4300 (296)	2800 (192)

① VCR components with fixed threads must remain stationary during installation. These fitting connections should be assembled only to glands with rotating male or female threaded nuts.

② Not designed for gasket retainer assembly.

Male Bulkhead Union ^①

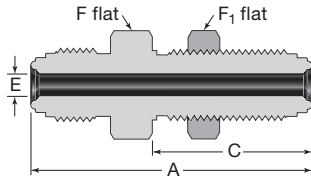

VCR Size	Ordering Number	Dimensions							Working Pressure		
		A	C	E	F	F ₁	Panel Hole Dia	Max Panel Thickness	Ni	SS	Cu
Dimensions, in. (mm)									psig (bar)		
1/4	SS-4-VCR-61	2.23 (56.6)	1.30 (33.0)	0.18 (4.6)	3/4	3/4	19/32 (15.0)	0.44 (11.2)	8000 (551)	10 000 (689)	6400 (440)
	SS-4-VCR-61S	1.82 (46.2)	0.99 (25.1)					0.13 (3.3)			
1/2	SS-8-VCR-61	2.57 (65.3)	1.48 (37.6)	0.40 (10.2)	1 1/16	1 1/16	29/32 (23.1)	0.50 (12.7)	3500 (241)	4300 (296)	2800 (192)
	SS-8-VCR-61S	2.14 (54.4)	1.11 (28.2)					0.13 (3.3)			

① VCR components with fixed threads must remain stationary during installation. These fitting connections should be assembled only to glands with rotating male or female threaded nuts.

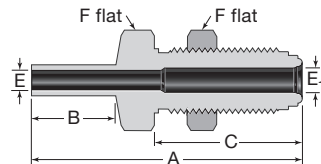

Tube Butt Weld Bulkhead Connector ^①

Tube Size	VCR Size	Ordering Number	Dimensions								Working Pressure		
			A	B	C	E	E ₁	F	Panel Hole Dia	Max Panel Thickness	Ni	SS	Cu
Dimensions, in. (mm)											psig (bar)		
1/4	1/4	6LV-4-VCR-61-4TB7	2.36 (59.9)	0.75 (19.1)	1.30 (33.0)	0.18 (4.6)	0.22 (5.6)	3/4	19/32 (15.0)	0.44 (11.2)	5100 (351)	5100 (351)	5100 (351)
		6LV-4-VCR-61S-4TB7	1.95 (49.5)		0.99 (25.1)					0.13 (3.3)			

① VCR components with fixed threads must remain stationary during normal installation. These fitting connections should be assembled only to glands with rotating male or female threaded nuts.

Bodies

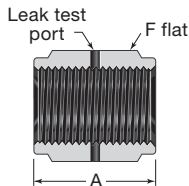

Coupling

VCR Size	Ordering Number	Dimensions	
		A	F
Dimensions, in. (mm)			
1/8	SS-2-VCR-CG	0.66 (16.8)	7/16
1/4	SS-4-VCR-CG	1.19 (30.2)	3/4
1/2	SS-8-VCR-CG	1.31 (33.3)	1 1/16
3/4	SS-12-VCR-CG	1.68 (42.7)	1 1/2
1	SS-16-VCR-CG	2.04 (51.8)	1 3/4

Female Reducing Union ①

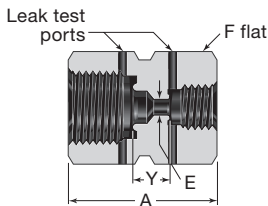

VCR Size	VCR Size	Ordering Number	Dimensions				Working Pressure		
			A	E	F	Y	Ni	SS	Cu
Dimensions, in. (mm)							psig (bar)		
1/4	1/8	SS-4-VCR-6-DF-2	1.16 (29.5)	0.13 (3.3)	3/4	0.36 (9.1)	8000 (551)	10 000 (689)	6400 (440)
1/2	1/4	SS-8-VCR-6-DF-4	1.41 (35.8)	0.25 (6.4)	1 1/16	0.35 (8.9)	3500 (241)	4300 (296)	2800 (192)

① VCR components with fixed threads must remain stationary during normal installation. These fitting connections should be assembled only to glands with rotating male or female threaded nuts.

Reducing Adapter ①

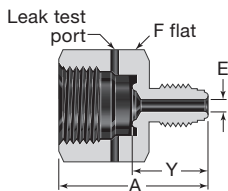

VCR Size	VCR Size	Ordering Number	Dimensions				Working Pressure		
			A	E	F	Y	Ni	SS	Cu
Dimensions, in. (mm)							psig (bar)		
1/8	1/4	SS-2-VCR-7-4VCRF ^②	1.19 (30.2)	0.09 (2.3)	3/4	0.69 (17.5)	8000 (551)	10 000 (689)	6400 (440)
1/4	1/2	SS-4-VCR-7-8VCRF	1.41 (35.8)	0.18 (4.6)	1 1/16	0.85 (21.6)	3500 (241)	4300 (296)	2800 (192)

① VCR components with fixed threads must remain stationary during normal installation. These fitting connections should be assembled only to glands with rotating male or female threaded nuts.

② Not designed for gasket retainer assembly.

Reducing Bushing ①

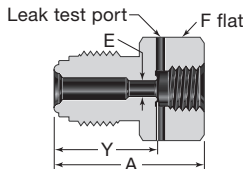

VCR Size	VCR Size	Ordering Number	Dimensions				Working Pressure		
			A	E	F	Y	Ni	SS	Cu
Dimensions, in. (mm)							psig (bar)		
1/4	1/8	SS-4-VCR-7-2VCRF	1.06 (26.9)	0.13 (3.3)	5/8	0.76 (19.3)	8000 (551)	10 000 (689)	6400 (440)
1/2	1/4	SS-8-VCR-7-4VCRF	1.41 (35.8)	0.25 (6.4)	15/16	0.91 (23.1)	3500 (241)	4300 (296)	2800 (192)

① VCR components with fixed threads must remain stationary during normal installation. These fitting connections should be assembled only to glands with rotating male or female threaded nuts.

Male NPT Elbow ①

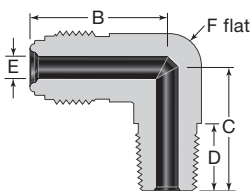

NPT Size	VCR Size	Ordering Number	Dimensions					Working Pressure		
			B	C	D	E	F	Ni	SS	Cu
Dimensions, in. (mm)								psig (bar)		
1/8	1/4	SS-4-VCR-2-2	1.07 (27.2)	0.87 (22.1)	0.38 (9.6)	0.18 (4.6)	1/2	8000 (551)	10 000 (689)	6400 (440)
1/4	1/4	SS-4-VCR-2-4	1.07 (27.2)	1.05 (26.7)	0.56 (14.2)	0.18 (4.6)	1/2	8000 (551)	8000 (551)	6400 (440)
3/8	1/2	SS-8-VCR-2-6	1.45 (36.8)	1.26 (32.0)	0.56 (14.2)	0.40 (10.2)	13/16	3500 (241)	4300 (296)	2800 (192)
1/2	1/2	SS-8-VCR-2-8	1.45 (36.8)	1.45 (36.8)	0.75 (19.1)	0.40 (10.2)	13/16	3500 (241)	4300 (296)	2800 (192)

① VCR components with fixed threads must remain stationary during normal installation. These fitting connections should be assembled only to glands with rotating male or female threaded nuts.

Bodies

Union Elbow ①

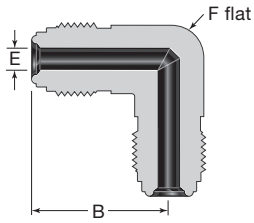

VCR Size	Ordering Number	Dimensions			Working Pressure		
		B	E	F	Ni	SS	Cu
Dimensions, in. (mm)					psig (bar)		
1/8	SS-2-VCR-9②	0.89 (22.6)	0.09 (2.3)	7/16	9000 (620)	11 200 (771)	7200 (496)
1/4	SS-4-VCR-9	1.07 (27.2)	0.18 (4.6)	1/2	8000 (551)	10 000 (689)	6400 (440)
1/2	SS-8-VCR-9	1.45 (36.8)	0.40 (10.2)	13/16	3500 (241)	4300 (296)	2800 (192)
3/4	SS-12-VCR-9	1.92 (48.8)	0.62 (15.7)	1 1/4	3000 (206)	3700 (254)	2400 (165)
1	SS-16-VCR-9	2.00 (50.8)	0.87 (22.1)	1 11/16	2400 (165)	3000 (206)	1900 (130)

- ① VCR components with fixed threads must remain stationary during normal installation. These fitting connections should be assembled only to glands with rotating male or female threaded nuts.
- ② Not designed for gasket retainer assembly.

Union Tee ①

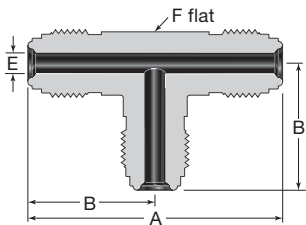

VCR Size	Ordering Number	Dimensions				Working Pressure		
		A	B	E	F	Ni	SS	Cu
Dimensions, in. (mm)					psig (bar)			
1/8	SS-2-VCR-T②	1.78 (45.2)	0.89 (22.6)	0.09 (2.3)	7/16	9000 (620)	11 200 (771)	7200 (496)
1/4	SS-4-VCR-T	2.14 (54.4)	1.07 (27.2)	0.18 (4.6)	1/2	8000 (551)	10 000 (689)	6400 (440)
1/2	SS-8-VCR-T	2.90 (73.7)	1.45 (36.8)	0.40 (10.2)	13/16	3500 (241)	4300 (296)	2800 (192)
3/4	SS-12-VCR-T	3.84 (97.5)	1.92 (48.8)	0.62 (15.7)	1 1/4	3000 (206)	3700 (254)	2400 (165)
1	SS-16-VCR-T	4.00 (102)	2.00 (50.8)	0.87 (22.1)	1 11/16	2400 (165)	3000 (206)	1900 (130)

- ① VCR components with fixed threads must remain stationary during normal installation. These fitting connections should be assembled only to glands with rotating male or female threaded nuts.
- ② Not designed for gasket retainer assembly.

Union Cross ①

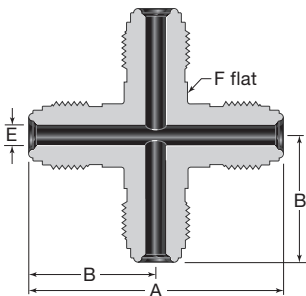

VCR Size	Ordering Number	Dimensions				Working Pressure		
		A	B	E	F	Ni	SS	Cu
Dimensions, in. (mm)					psig (bar)			
1/8	SS-2-VCR-CS②	1.78 (45.2)	0.89 (22.6)	0.09 (2.3)	7/16	9000 (620)	11 200 (771)	7200 (496)
1/4	SS-4-VCR-CS	2.14 (54.4)	1.07 (27.2)	0.18 (4.6)	1/2	8000 (551)	10 000 (689)	6400 (440)
1/2	SS-8-VCR-CS	2.90 (73.7)	1.45 (36.8)	0.40 (10.2)	13/16	3500 (241)	4300 (296)	2800 (192)
3/4	SS-12-VCR-CS	3.84 (97.5)	1.92 (48.8)	0.62 (15.7)	1 1/4	3000 (206)	3700 (254)	2400 (165)
1	SS-16-VCR-CS	4.00 (102)	2.00 (50.8)	0.87 (22.1)	1 11/16	2400 (165)	3000 (206)	1900 (130)

- ① VCR components with fixed threads must remain stationary during normal installation. These fitting connections should be assembled only to glands with rotating male or female threaded nuts.
- ② Not designed for gasket retainer assembly.

Welded Assemblies

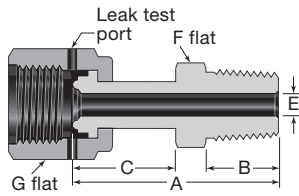

Male NPT Connector

NPT Size	VCR Size	Ordering Number	Dimensions						Working Pressure		
			A	B	C	E	F	G	Ni	SS	Cu
Dimensions, in. (mm)									psig (bar)		
1/8	1/4	SS-4-WVCR-1-2	1.58 (40.1)	0.38 (9.6)	0.95 (24.1)	0.18 (4.6)	7/16	3/4	8000 (551)	8000 (551)	6400 (440)
1/4	1/4	SS-4-WVCR-1-4	1.79 (45.5)	0.56 (14.2)	0.92 (23.4)	0.18 (4.6)	9/16	3/4	8000 (551)	8000 (551)	6400 (440)
3/8	1/2	SS-8-WVCR-1-6	1.89 (48.0)	0.56 (14.2)	1.00 (25.4)	0.40 (10.2)	11/16	1 1/16	3500 (241)	4300 (296)	2800 (192)
1/2	1/2	SS-8-WVCR-1-8	2.09 (53.1)	0.75 (19.1)	1.01 (25.6)	0.40 (10.2)	7/8	1 1/16	3500 (241)	4300 (296)	2800 (192)

Female NPT Connector

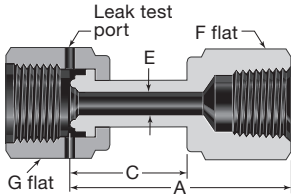

NPT Size	VCR Size	Ordering Number	Dimensions					Working Pressure		
			A	C	E	F	G	Ni	SS	Cu
Dimensions, in. (mm)								psig (bar)		
1/4	1/4	SS-4-WVCR-7-4	1.77 (45.0)	0.92 (23.4)	0.18 (4.6)	3/4	3/4	6600 (454)	6600 (454)	6400 (440)
3/8	1/2	SS-8-WVCR-7-6	1.95 (49.5)	1.06 (26.9)	0.40 (10.2)	7/8	1 1/16	3500 (241)	4300 (296)	2800 (192)
1/2	1/2	SS-8-WVCR-7-8	2.18 (55.4)	1.04 (26.4)	0.40 (10.2)	1 1/16	1 1/16	3500 (241)	4300 (296)	2800 (192)

Swagelok Tube Fitting Connector

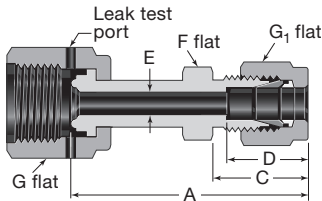

Tube Size	VCR Size	Ordering Number	Dimensions							Working Pressure		
			A	C	D	E	F	G	G ₁	Ni	SS	Cu
Dimensions, in. (mm)									psig (bar)			
1/4	1/4	SS-4-WVCR-6-400	1.94 (49.3)	0.70 (17.8)	0.60 (15.2)	0.18 (4.6)	1/2	3/4	9/16	8000 (551)	10 000 (689)	6400 (440)
3/8	1/4	SS-4-WVCR-6-600	1.97 (50.0)	0.76 (19.3)	0.66 (16.8)	0.18 (4.6)	5/8	3/4	11/16	7500 (517)	7500 (517)	6400 (440)
1/2	1/2	SS-8-WVCR-6-810	2.23 (56.6)	0.86 (21.8)	0.90 (22.9)	0.40 (10.2)	13/16	1 1/16	7/8	3500 (241)	4300 (296)	2800 (192)

Dimensions A, C, and D are typical finger-tight.

Swagelok nuts and ferrules are provided assembled, as shown.

For tubing maximum pressure ratings for use with Swagelok tube fittings, see Swagelok *Tubing Data*, [MS-01-107](#).

Rotating Female Union

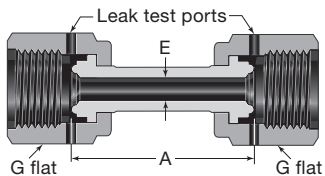

VCR Size	Ordering Number	Dimensions			Working Pressure		
		A	E	G	Ni	SS	Cu
Dimensions, in. (mm)							
1/4	SS-4-WVCR-6-DF	1.71 (43.4)	0.18 (4.6)	3/4	8000 (551)	10 000 (689)	6400 (440)
1/2	SS-8-WVCR-6-DF	1.84 (46.7)	0.40 (10.2)	1 1/16	3500 (241)	4300 (296)	2800 (192)

Elbows, crosses, Micro-Fit® fittings, and tees are available with welded male and female ends.

For more information, contact your authorized Swagelok sales and service representative.

Female Elbow

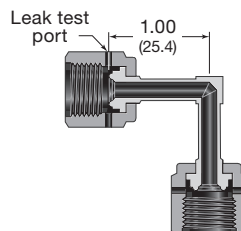

Ordering number:
6LV-4-WVCR-9-DF

Female Tee

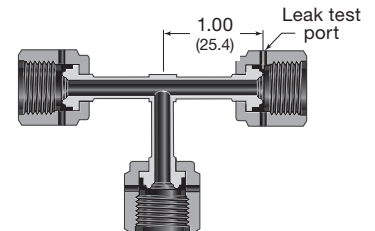

Ordering number:
6LV-4-WVCR-T-FFF

Nuts, Caps, and Plugs

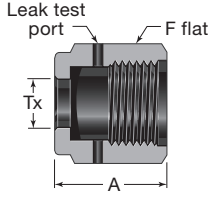

Female Nut

VCR Size	Ordering Number	Dimensions		
		A	F	Tx
Dimensions, in. (mm)				
1/8	SS-2-VCR-1	0.53 (13.5)	7/16	0.21 (5.3)
1/4	SS-4-VCR-1	0.81 (20.6)	3/4	0.36 (9.1)
1/2	SS-8-VCR-1	0.88 (22.4)	1 1/16	0.61 (15.5)
5/8	SS-10-VCR-1	0.88 (22.4)	1 3/16	0.74 (18.8)
3/4	SS-12-VCR-1	1.12 (28.4)	1 1/2	0.89 (22.6)
1	SS-16-VCR-1	1.34 (34.0)	1 3/4	1.20 (30.5)

Male Nut

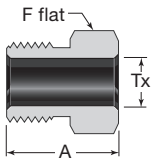

VCR Size	Ordering Number	Dimensions		
		A	F	Tx
Dimensions, in. (mm)				
1/8	SS-2-VCR-4	0.50 (12.7)	3/8	0.21 (5.3)
1/4	SS-4-VCR-4 ^①	0.71 (18.0)	5/8	0.36 (9.1)
1/2	SS-8-VCR-4	0.81 (20.6)	15/16	0.61 (15.5)
5/8	SS-10-VCR-4	0.81 (20.6)	1 1/16	0.74 (18.8)
3/4	SS-12-VCR-4	1.00 (25.4)	1 5/16	0.89 (22.6)
1	SS-16-VCR-4	1.19 (30.2)	1 5/8	1.20 (30.5)

① A taper at the hex end allows the nut to move around 90° tube bends.

Short Male Nut

For use with short gland.

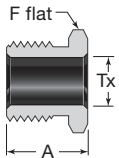

VCR Size	Ordering Number	Dimensions		
		A	F	Tx
Dimensions, in. (mm)				
1/4	SS-4-VCR-4-.54NC	0.54 (13.7)	5/8	0.36 (9.1)
	SS-4-VCR-4-.65NC	0.65 (16.5)		

Cap

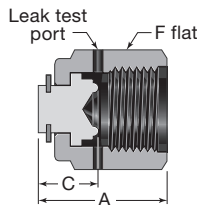

VCR Size	Ordering Number	Dimensions		
		A	C	F
Dimensions, in. (mm)				
1/8	SS-2-VCR-CP	0.63 (16.0)	0.30 (7.6)	7/16
1/4	SS-4-VCR-CP	0.94 (23.9)	0.44 (11.2)	3/4
1/2	SS-8-VCR-CP	1.01 (25.6)	0.45 (11.4)	1 1/16
3/4	SS-12-VCR-CP	1.29 (32.8)	0.54 (13.7)	1 1/2
1	SS-16-VCR-CP	1.54 (39.1)	0.63 (16.0)	1 3/4

Cap with Lanyard

Lanyard material is 302 SS.
Lanyard length is 6 in. (15.2 cm).

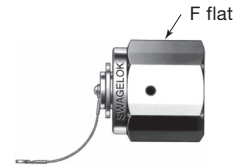

VCR Size	Ordering Number	Dimensions		
		A	C	F
Dimensions, in. (mm)				
1/4	SS-4-VCR-CP-BP	0.94 (23.9)	0.44 (11.2)	3/4
1/2	SS-8-VCR-CP-BP	1.01 (25.6)	0.45 (11.4)	1 1/16

Plug

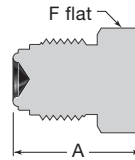

VCR Size	Ordering Number	Dimensions	
		A	F
Dimensions, in. (mm)			
1/8	SS-2-VCR-P ^①	0.68 (17.3)	3/8
1/4	SS-4-VCR-P ^②	0.92 (23.4)	5/8
1/2	SS-8-VCR-P	1.08 (27.4)	15/16
3/4	SS-12-VCR-P	1.43 (36.3)	1 5/16
1	SS-16-VCR-P	1.52 (38.6)	1 5/8

① Not designed for gasket retainer assembly.

② Also available as a rotatable plug.
Ordering number: **SS-4-VCR-RP**

Plug with Lanyard

Lanyard material is 302 SS.
Lanyard length is 6 in. (15.2 cm).

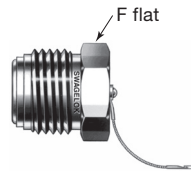

VCR Size	Ordering Number	Dimensions	
		A	F
Dimensions, in. (mm)			
1/4	SS-4-VCR-BP	0.92 (23.4)	5/8
1/2	SS-8-VCR-BP	1.08 (27.4)	15/16

Nuts, Caps, and Plugs

Split-Nut Assemblies

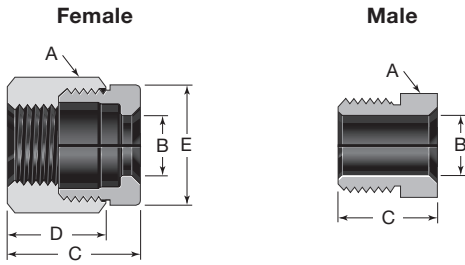

VCR Size	Split Nut Type	Ordering Number	Dimensions				
			A	B	C	D	E
Dimensions, in. (mm)							
1/4	Female	SS-4-VCR-1-SN	3/4	0.36 (9.1)	0.81 (20.6)	0.63 (16.0)	0.68 (17.4)
1/4	Male	SS-4-VCR-4-SN	5/8	0.36 (9.1)	0.60 (15.2)	—	—

Material is S17400.

High-Flow Connections – “H” Type VCR

“H” Type VCR connections are compatible with 1/4 in. VCR connections and are designed for use with Swagelok high-flow diaphragm valves and gas regulators. For uniform flow, use 1/4 in. side-load retainer style gasket. See page 17.

Glands

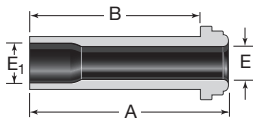

Tube Butt Weld

Tube Size	Nominal Wall Thickness	VCR Size	Ordering Number	Dimensions				Working Pressure		
				A	B	E	E ₁	Ni	SS	Cu
Dimensions, in. (mm)								psig (bar)		
3/8	0.035	1/4	6LV-4-HVCR-3-.60SR	0.60 (15.2)	0.41 (10.4)	0.25 (6.4)	0.31 (7.9)	3300 (227)	3300 (227)	3300 (227)
			6LV-4-HVCR-3-1.19SR	1.19 (30.2)	1.00 (25.4)					
			6LV-4-HVCR-3-1.31SR	1.31 (33.3)	1.12 (28.4)					

Bodies

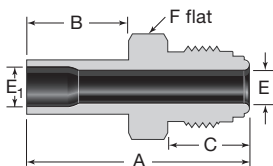

Tube Butt Weld

Tube Size	VCR Size	Ordering Number	Dimensions					Working Pressure			
			A	B	C	E	E ₁	F	Ni	SS	Cu
Dimensions, in. (mm)								psig (bar)			
3/8	1/4	6LV-4-HVCR-1-6TB7	1.68 (42.7)	0.75 (19.1)	0.62 (15.7)	0.25 (6.4)	0.31 (7.9)	5/8	3300 (227)	3300 (227)	3300 (227)

Automatic Tube Weld

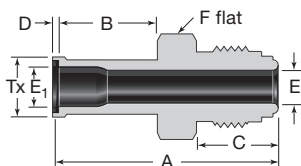

Tube Size	VCR Size	Ordering Number	Dimensions							Working Pressure			
			A	B	C	D	E	E ₁	F	Tx	Ni	SS	Cu
Dimensions, in. (mm)										psig (bar)			
3/8	1/4	316L-4-HVCR-1A6	1.71 (43.4)	0.75 (19.1)	0.62 (15.7)	0.03 (0.8)	0.25 (6.4)	0.31 (7.9)	5/8	0.41 (10.4)	3300 (227)	3300 (227)	3300 (227)

High-Flow Connections – “H” Type VCR

Bodies

Bulkhead Connector

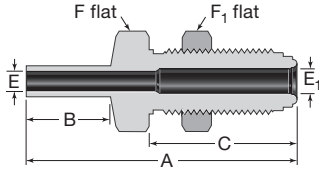

Tube Size	VCR Size	Ordering Number	Dimensions									Working Pressure			
			A	B	C	E	E ₁	F	F ₁	Panel Hole Dia	Max Panel Thickness	Ni	SS	Cu	
Dimensions, in. (mm)													psig (bar)		
3/8	1/4	6LV-4-HVCR-61-6TB7	2.36 (59.9)	0.75 (19.1)	1.30 (33.0)	0.31 (7.9)	0.25 (6.4)	3/4	3/4	19/32 (15.0)	0.44 (11.2)	3300 (227)	3300 (227)	3300 (227)	

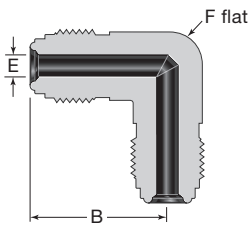

Union Elbow

VCR Size	Ordering Number	Dimensions			Working Pressure					
		B	E	F	Ni	SS	Cu			
Dimensions, in. (mm)								psig (bar)		
1/4	SS-4-HVCR-9	1.07 (27.2)	0.25 (6.4)	1/2	8000 (551)	10 000 (689)	6400 (440)			

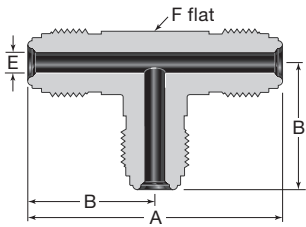

Union Tee

VCR Size	Ordering Number	Dimensions				Working Pressure					
		A	B	E	F	Ni	SS	Cu			
Dimensions, in. (mm)									psig (bar)		
1/4	SS-4-HVCR-T	2.14 (54.4)	1.07 (27.2)	0.25 (6.4)	1/2	8000 (551)	10 000 (689)	6400 (440)			

Nuts

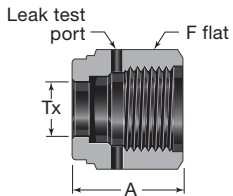

Female

VCR Size	Ordering Number	Dimensions		
		A	F	Tx
Dimensions, in. (mm)				
1/4	SS-4-HVCR-1SR	0.81 (20.6)	3/4	0.39 (9.9)
	SS-4-HVCR-1			0.46 (11.7)

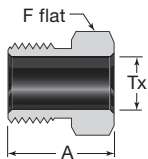

Male

VCR Size	Ordering Number	Dimensions		
		A	F	Tx
Dimensions, in. (mm)				
1/4	SS-4-HVCR-4SR	0.71 (18.0)	5/8	0.39 (9.9)

Gaskets

Ordering Information

Specify gasket material by adding a material designator to the basic ordering number.

Material	Designator	Example
Nickel	NI	NI-4-VCR-2-VS
316L stainless steel	SS	SS-4-VCR-2-VS
Copper	CU ^①	CU-4-VCR-2

Nickel and copper gasket retainer assemblies use a 316 stainless steel retainer.

① Copper gaskets are unplated as standard.

Side-load retainer style gaskets are not available in copper.

Options

Blind Gaskets

Blind (undrilled) gaskets are available in nonretained and retainer assembly styles. Blind gaskets have a maximum differential pressure rating (Δp) of 100 psi (6.8 bar).

To order, add **-BL** to a basic ordering number.

Example: SS-4-VCR-2-VS-**BL**

Silver Plated

Nonretained

Cannot be used in a gasket retainer assembly.

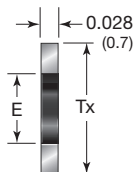

VCR Size	Basic Ordering Number	Dimensions	
		E	Tx
Dimensions, in. (mm)			
1/8	-2-VCR-2	0.09 (2.3)	0.26 (6.6)
1/4	-4-VCR-2	0.22 (5.6)	0.47 (11.9)
1/2	-8-VCR-2	0.44 (11.2)	0.78 (19.8)
5/8	-10-VCR-2	0.58 (14.7)	0.91 (23.1)
3/4	-12-VCR-2	0.66 (16.8)	1.14 (29.0)
1	-16-VCR-2	0.89 (22.6)	1.40 (35.6)

Unplated (VS)

Nonretained

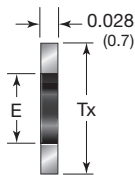

VCR Size	Basic Ordering Number	Dimensions	
		E	Tx
Dimensions, in. (mm)			
1/8	-2-VCR-2-VS	0.09 (2.3)	0.26 (6.6)
1/4	-4-VCR-2-VS	0.22 (5.6)	0.47 (11.9)
1/2	-8-VCR-2-VS	0.44 (11.2)	0.78 (19.8)
5/8	-10-VCR-2-VS	0.58 (14.7)	0.91 (23.1)
3/4	-12-VCR-2-VS	0.66 (16.8)	1.14 (29.0)
1	-16-VCR-2-VS	0.89 (22.6)	1.40 (35.6)

Gasket Retainer Assembly

Retainer and gasket must be used as an assembly.

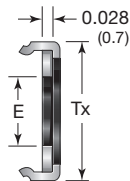

VCR Size	Basic Ordering Number	Dimensions	
		E	Tx
Dimensions, in. (mm)			
1/4	-4-VCR-2-GR	0.24 (6.1)	0.50 (12.7)
1/2	-8-VCR-2-GR	0.44 (11.2)	0.79 (20.1)
3/4	-12-VCR-2-GR	0.66 (16.8)	1.14 (29.0)
1	-16-VCR-2-GR	0.89 (22.6)	1.40 (35.6)

Gasket Retainer Assembly

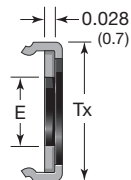

VCR Size	Basic Ordering Number	Dimensions	
		E	Tx
Dimensions, in. (mm)			
1/4	-4-VCR-2-GR-VS	0.24 (6.1)	0.50 (12.7)
1/2	-8-VCR-2-GR-VS	0.44 (11.2)	0.79 (20.1)
3/4	-12-VCR-2-GR-VS	0.66 (16.8)	1.14 (29.0)
1	-16-VCR-2-GR-VS	0.89 (22.6)	1.40 (35.6)

Side-Load Retainer

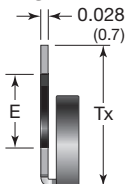

VCR Size	Basic Ordering Number	Dimensions	
		E	Tx
Dimensions, in. (mm)			
1/4	-4-VCR-2-ZC-VS	0.24 (6.1)	0.45 (11.4)
1/2	-8-VCR-2-ZC-VS	0.43 (11.0)	0.75 (19.1)

Flow Restrictors

This product can be used in liquid or gas delivery systems where repeatable flow reduction or limiting is required.



- One piece, compact design saves space
- Standard orifice sizes drilled through a 1/4 in. male VCR union
- No dead volume for clean operation
- Identification of orifice and heat code marked clearly on the body
- Electropolished, cleaned, and packaged in accordance with Swagelok *Ultrahigh-Purity Process Specification (SC-01)*, [MS-06-61](#)

Working Pressure		
Ni	SS	Cu
Dimensions, psig (bar)		
8 000 (551)	10 000 (689)	6 400 (440)

Ordering Information and Dimensions

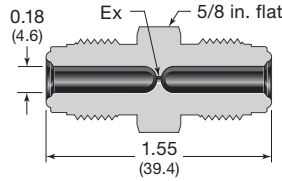

VCR components with fixed threads must remain stationary during normal installation. These fitting connections should be assembled only to glands with rotating female nuts.

Ex, in. (mm)	Ordering Number
0.010 (0.254)	6LV-4-VCR-6-DM-010P
0.012 (0.305)	6LV-4-VCR-6-DM-012P
0.015 (0.381)	6LV-4-VCR-6-DM-015P
0.017 (0.432)	6LV-4-VCR-6-DM-017P
0.020 (0.508)	6LV-4-VCR-6-DM-020P
0.023 (0.584)	6LV-4-VCR-6-DM-023P
0.025 (0.635)	6LV-4-VCR-6-DM-025P
0.026 (0.660)	6LV-4-VCR-6-DM-026P
0.027 (0.686)	6LV-4-VCR-6-DM-027P
0.030 (0.762)	6LV-4-VCR-6-DM-030P
0.035 (0.889)	6LV-4-VCR-6-DM-035P
0.040 (1.016)	6LV-4-VCR-6-DM-040P
0.045 (1.143)	6LV-4-VCR-6-DM-045P

Ex, in. (mm)	Ordering Number
0.050 (1.270)	6LV-4-VCR-6-DM-050P
0.055 (1.397)	6LV-4-VCR-6-DM-055P
0.060 (1.529)	6LV-4-VCR-6-DM-060P
0.065 (1.651)	6LV-4-VCR-6-DM-065P
0.070 (1.778)	6LV-4-VCR-6-DM-070P
0.075 (1.905)	6LV-4-VCR-6-DM-075P
0.080 (2.032)	6LV-4-VCR-6-DM-080P
0.085 (2.159)	6LV-4-VCR-6-DM-085P
0.090 (2.286)	6LV-4-VCR-6-DM-090P
0.093 (2.362)	6LV-4-VCR-6-DM-093P
0.095 (2.413)	6LV-4-VCR-6-DM-095P
0.100 (2.540)	6LV-4-VCR-6-DM-100P

Lock and Tag Devices

These devices help prevent unintentional disassembly of VCR connections. Additionally, both devices include a wire hole to allow for a tag to support identification and quality verification programs.

Fitting Lock Device

This device is intended for use on Swagelok VCR metal gasket face seal assemblies with standard male and female nuts.

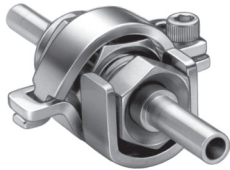

Size	Ordering Number
1/4 in.	SS-4-VCR-FLC
1/2 in.	SS-8-VCR-FLC

Fitting Lock Device for Valves

This device is intended for use on Swagelok valves with integrally machined male VCR metal gasket face seal end connections.



Size	Valve Series	Ordering Number
1/4 in.	ALD3, ALD3T, BN4, DL, DS, DP, DPH, HB, 4BK, 4BMG, 4BMRG, 4BMW, 4BMRW, 4UG, 4UK	SS-4-VCR-VLC
1/2 in.	8BG, 8BK, 8UG, 8UK, 8UW	SS-8-VCR-VLC

For fitting lock devices for valves not listed, contact your authorized Swagelok representative.

Side-Load Installation Tool and Tray

Tool

- Makes gasket handling easy, preserves cleanliness
- Enables gasket installation where space is limited
- Is used to easily remove gasket from storage tray





Material:

Polyethersulfone (PES)

Tray (includes 30 gaskets; order in multiples of 30)

- Keeps gaskets secure
- Keeps gaskets aligned for easy removal with side-load gasket tool
- Cleaned and packaged in accordance with Swagelok *Ultrahigh-Purity Process Specification (SC-01)*, [MS-06-61](#)

Material:

Tray — polypropylene 
 Lid — polycarbonate 

Description	Ordering Number
Installation tool	MS-4-VCR-ZC-TL
Tray (nickel gaskets)	NI-4-VCR-2-ZCT-VS
Tray (SS gaskets)	SS-4-VCR-2-ZCT-VS

VCR Fitting Installation Instructions

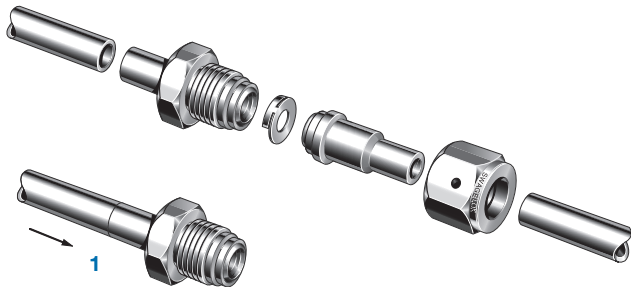

1

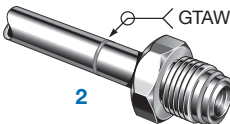

2

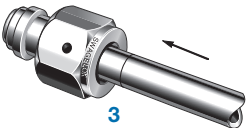
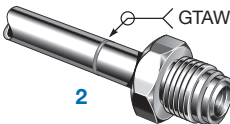

3

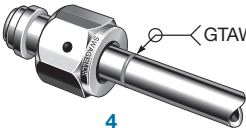

4

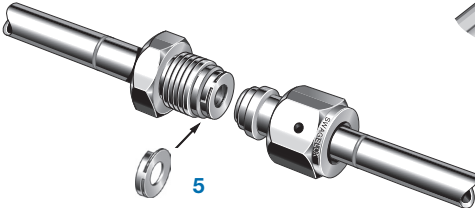

5

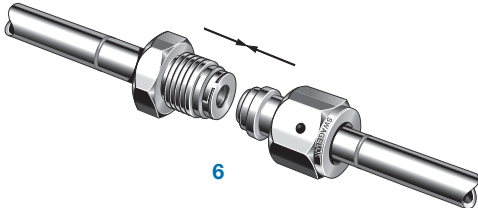

6

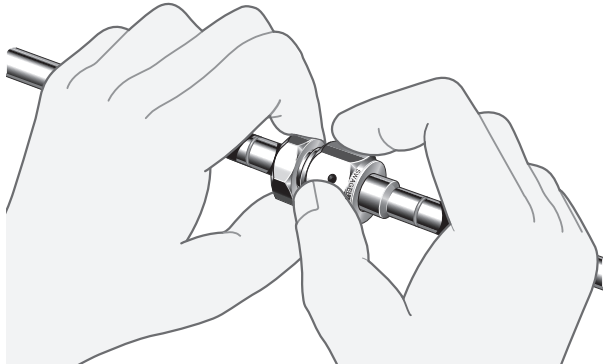

7 Finger-tight

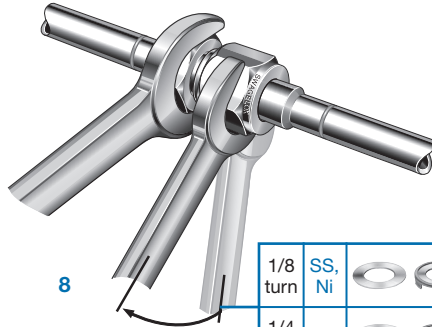

8

1/8 turn	SS, Ni	
1/4 turn	Cu	



VCR Split-Nut Installation Instructions

Male

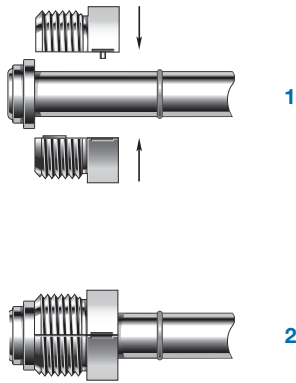

Female

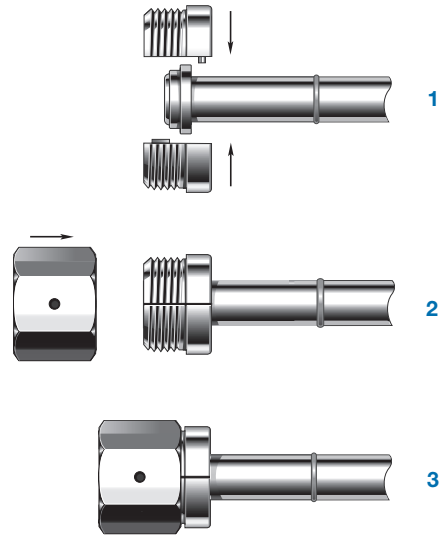

Swagelok Orbital Welding System

See the *Swagelok Welding System M200 Power Supply* catalog, [MS-02-342](#) for more information.



Safe Product Selection

When selecting a product, the total system design must be considered to ensure safe, trouble-free performance. Function, material compatibility, adequate ratings, proper installation, operation, and maintenance are the responsibilities of the system designer and user.

⚠ WARNING

Do not mix/interchange Swagelok products or components not governed by industrial design standards, including Swagelok tube fitting end connections, with those of other manufacturers.

Warranty Information

Swagelok products are backed by The Swagelok Limited Lifetime Warranty. For a copy, visit [swagelok.com](#) or contact your authorized Swagelok representative.